



永生模业

YONGSHENGMOULD

铸造辉煌 唯有品质
Casting brilliant, only by quality



公司简介

Company profile

台州市黄岩永生模业有限公司成立于2011年，位于浙江省中国模具之乡黄岩。周边环境优美，交通便捷，地理位置优越。靠近附近的杭州和宁波港，我们开发，针阀瓶坯模具，各种瓶盖模具，自动翻盖模具，医用注塑模具，管件模具，吹瓶模具，家用模具等。采用世界先进的CAD / UG / VT / St设计软件，拥有资深专家和优质生产设备。

我们致力于以最短的时间为国内外客户提供高品质，有竞争力的产品和服务。为客户提供高品质的模具外观，并以优越的服务满足客户的各种要求。坚持“质量定位，以客户为中心，诚信为本”的方针，创新技术，产品创新，企业持续，快速，健康发展。我们拥有一支高素质的技术团队，聚集了一批年轻而充满活力的行业成员，他们充满动手实践的创造力，始终不懈努力。公司不断完善自身管理和升级技术研发能力，同时推动中国模具业的发展。

Taizhou Huangyan Yongsheng Mold Industry Co., Ltd. was established in 2011 and is located in Huangyan, the hometown of molds in China, Zhejiang Province. The surrounding environment is beautiful, the transportation is convenient and the geographical location is superior. Close to nearby Hangzhou and Ningbo ports, we develop, needle valve preform molds, various bottle cap molds, automatic flip cap molds, medical injection molds, pipe fitting molds, bottle blowing molds, household molds, etc. Using the world's advanced CAD/UG/VT/St design software, we have senior experts and high-quality production equipment.

We are committed to providing domestic and foreign customers with high-quality, competitive products and services in the shortest possible time. Provide customers with high-quality mold appearance and meet customers' various requirements with superior services. Adhering to the policy of "quality orientation, customer-centered, integrity-based", innovative technology, product innovation, the company has sustained, rapid and healthy development. We have a high-quality technical team and have gathered a group of young and energetic industry members who are full of hands-on creativity and always work tirelessly. The company continues to improve its own management and upgrade its technology research and development capabilities, while promoting the development of China's mold industry.



自动翻盖 Automatic flip

一般用于食品酱油、醋、玻璃瓶与PET塑料瓶上的盖子，盖子里中心有撕拉与不撕拉两种。还有就是洗漱用品里LDPE瓶、PP瓶\HDPE瓶的各种各样的形状瓶上的翻盖，由椭圆形、圆形大小尺寸。用翻盖第一为了适合瓶子形状的美观，而是为了方便手翻开与关闭，这里就会反映翻盖的关节手感干刚好跟封水紧密度。翻盖模具结构上螺纹有套顶出，跟螺纹自动旋转在翻盖的基础上，模具结构多了够装置，自动翻盖，不需要产品出来再闭合盖子，直接在模具注塑成型后直接闭合翻盖，这项模具节省了人工闭合盖子的费用，省了一道工序。模具需要更精密的加工跟合理性的设计。完美的闭合动作为客户节省了一大笔费用。模具镶件采用不锈钢进口材料，热流道是国际品牌，气缸是台湾进口，闭合装置达到行业领先。

Generally used for caps on food soy sauce, vinegar, glass bottles, and PET plastic bottles, there are two types of caps in the center: tear and non tear. There are also various shapes of LDPE bottles, PP bottles, and HDPE bottles in toiletries, with flip caps on them, ranging in size from oval to circular. The first reason for using a flip cap is to fit the shape of the bottle beautifully, but to facilitate hand opening and closing. This will reflect the dry joint feel of the flip cover, which is just as tight as the sealing water. On the structure of the flip cap mold, the threads are pushed out and automatically rotated on the basis of the flip cap. The mold structure has enough devices to automatically flip the cap, without the need for the product to come out and close the cap. The flip cover is directly closed after injection molding in the mold. This mold saves the cost of manually closing the cover and saves one process. Molds require more precise machining and rational design. The perfect closing action saved customers a lot of money. The mold inserts are made of imported stainless steel materials, the hot runner is an international brand, the cylinder is imported from Taiwan, and the closing device is industry-leading

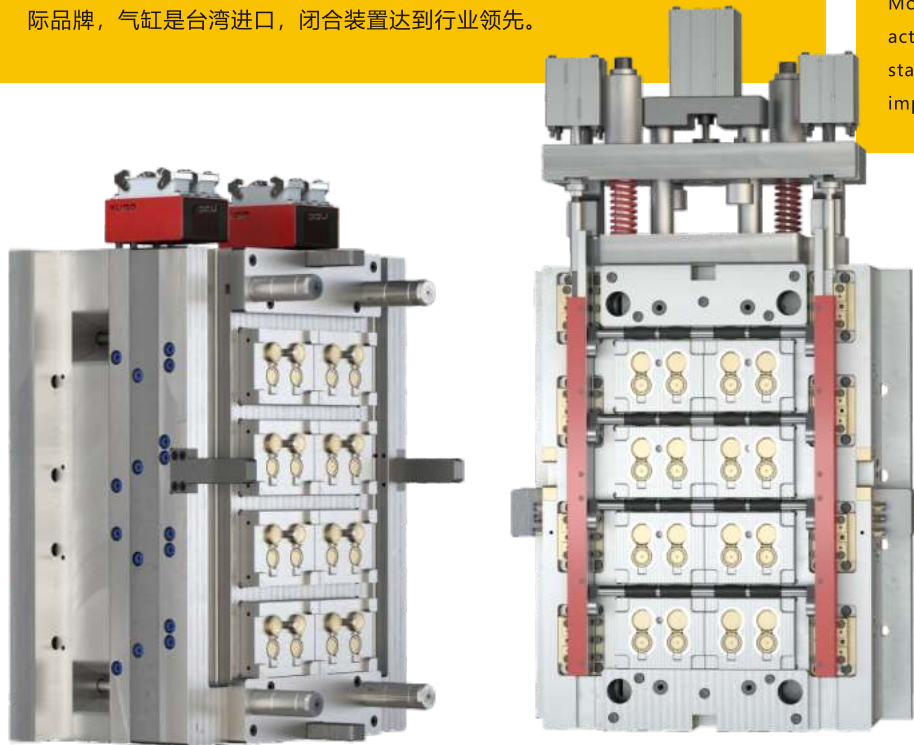

YONGSHENGMOULD

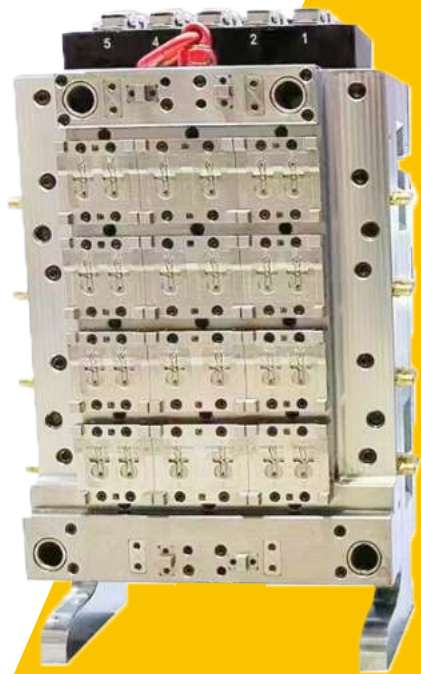

食品包装盖 Food packaging cover

1. 模具范围从1腔到72腔。
2. 模具由不锈钢制成。
3. 标准可互换模具组件
4. 高性能热流道系统确保所有型腔均匀的熔体流动和压力。
5. 所有零件均由CNC设备制造。
6. 先进的结构设计。
7. 模腔和型芯采用钢材精制而成，具有高抛光，高硬度，耐腐蚀，使模具精度高，质量好。
8. 气动驱动喷嘴销，同时进行高速开闭动作。
9. 采用专利设计的整流系统，减少生产过程中可能出现的预制件厚度问题。
10. 特殊设计的水管可消除瓶坯上的泄漏和水痕。
11. 模流分析降低了AA水平。
12. 使用寿命长达250万次注射周期。

1. Mold ranges from 1 cavity to 72 cavities.
2. The mold plate is made of stainless steel.
3. Standard interchangeable mold components
4. High performance hot runner system ensures uniform melt flow and pressure in all cavities.
5. All of parts are manufactured by CNC equipments.
6. Advanced structure is designed consulting European cap mold.
7. Mold cavity and Core are made of steel with fine polishing, high hardness and anti-corrosion to get mold's high precision and good quality.
8. Pneumatic drive the nozzle pin for simultaneous high-speed open and close actions.
9. Patent designed rectifying system is adopted to lessen the possible preform thickness problem happening during production.
10. Special designed water hoses eliminate leakage and water marks on preform.
11. Mold flow analysis reduce AA level.
12. Long using life over 2.5 million times of injection cycle.



YONGSHENGMOULD

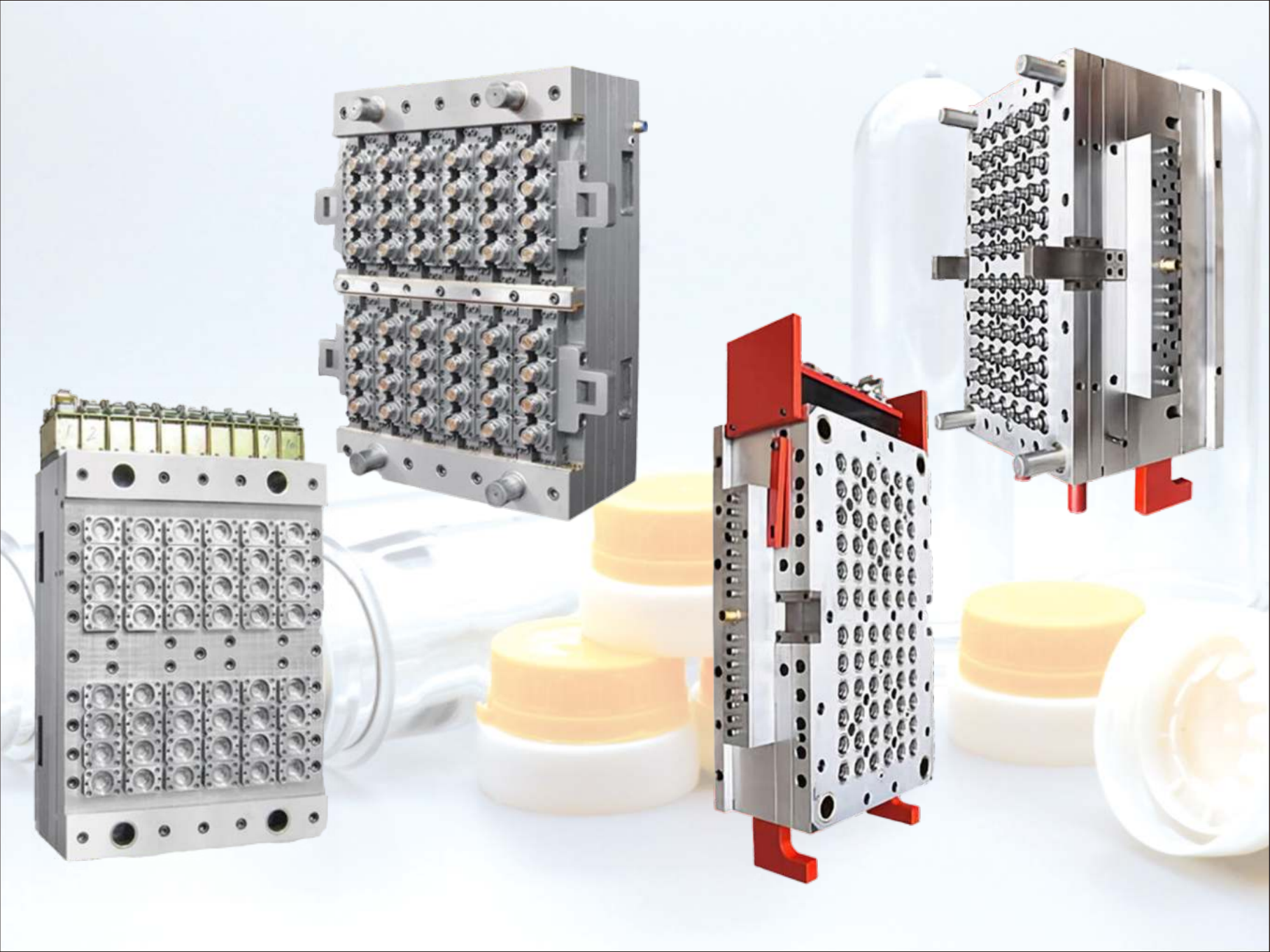

五加仑盖 5 gallon cap

五加仑瓶盖模具是用于生产五加仑水桶瓶盖的专用模具。通常用于饮水机上桶装水盖，盖子中心一次性捅破，还要不漏水，方便桶盖装入饮水机，倒装入一次性捅破水灌入饮水机引用。这盖子模具设计重点就是一次性能破，模具要高精密的机床加工，跟合理的设计。镶件全部内磨圆加工，精度更高，材料采用不锈钢H13、S136、632，硬度需要48-50度还有一部分是注塑工艺原料的配比，机器要足够的锁模力保证中心方便干净利落的捅破。模具的冷却系统也需要设计得当，以确保瓶盖在注塑完成后能够快速冷却并脱模。顶出加上气吹形式完全能脱离，我们有实操的丰富你经验可供客户参考学习。

The 5 gallon bottle cap mold is a specialized mold used to produce 5 gallon bucket bottle caps. Usually used for bucket water caps on water dispensers, the center of the cap is punctured in one go without leaking water, making it convenient for the bucket cap to be inserted into the water dispenser, and then poured into the water dispenser for reference. The key point of this cap mold design is that it can be broken in one go. The mold needs to be processed with high-precision machine tools and designed reasonably. All the inserts are internally ground and processed with higher precision. The materials used are stainless steel H13, S136, and 632, with a hardness of 48-50 degrees. Additionally, a portion of the materials used in the injection molding process are matched. The machine needs sufficient locking force to ensure that the center is easily and cleanly punctured. The cooling system of the mold also needs to be designed properly to ensure that the bottle cap can quickly cool and demold after injection molding is completed. The combination of ejection and air blowing can completely detach, and we have rich practical experience to provide customers with reference and learning.

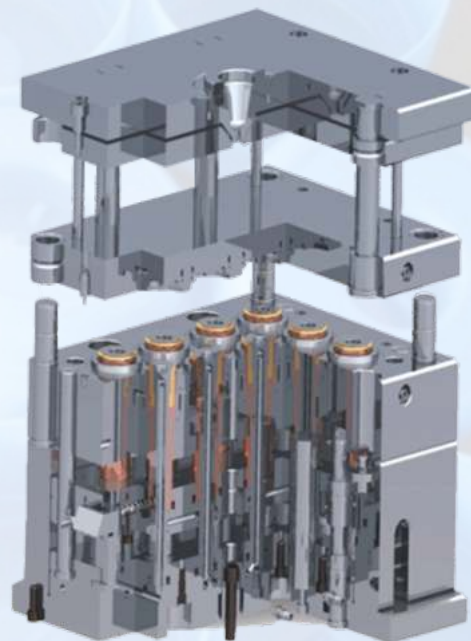

| 广口食品级塑料盖 Food wide mouth cap



撕拉防盗盖模具 Easy to tear off anti-theft cap

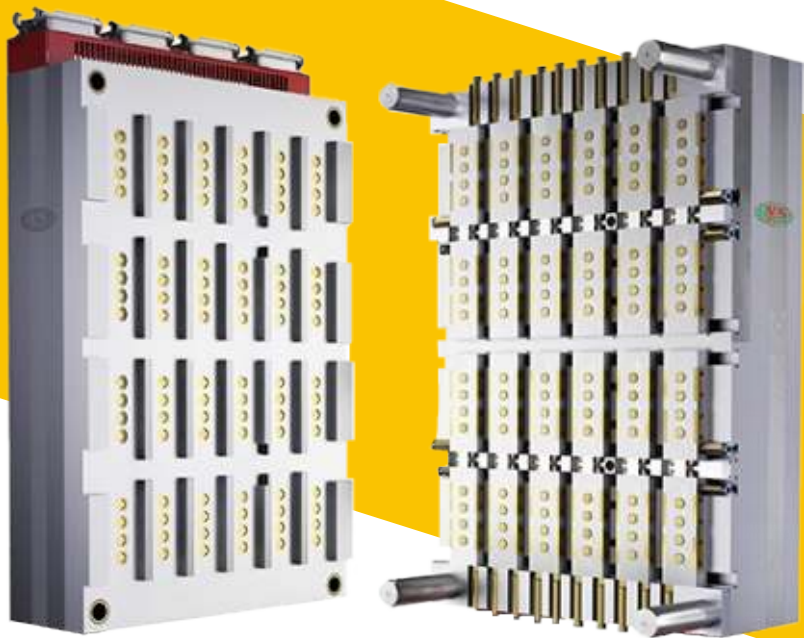

瓶坯模具-PET管坯模具 Pet preform mould

1-128腔模具：这表示模具可以一次性生产1到128个瓶胚，具体腔数可以根据生产需求进行调整。

瓶口从10MM-200MM：这定义了模具可以生产的瓶胚的瓶口尺寸范围，从较小的10毫米到较大的200毫米。

独立自锁锁气动针阀管坯模具：这意味着模具采用了先进的气动针阀技术，每个腔体都具备独立的自锁功能，这可以确保在生产过程中瓶胚的稳定性和精确度。

同心度0.05以内：这是模具加工精度的关键指标之一，表示模具生产的瓶胚在同心度方面需要达到非常高的精度，确保瓶胚的质量和使用效果。

采用不锈钢材料2316、S136、632：这些不锈钢材料都是优质的模具钢材材料，具有良好的耐腐蚀性、耐磨性和耐高温性，能够保证模具的长期稳定运行和瓶胚的高质量生产。

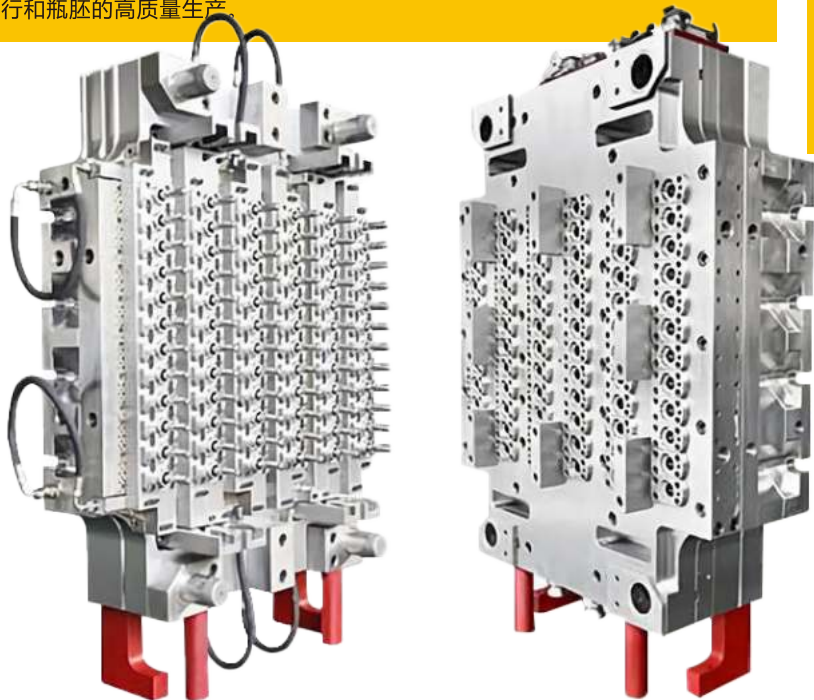

1-128 cavity mold: This means that the mold can produce 1-128 pcs preform at once, and the specific number of cavities can be adjusted according to the production requirements.

The bottle mouth ranges from 10MM-200MM: This defines the range of bottle mouth sizes that the mold can produce for preforms, from a smaller 10mm to a larger 200mm.

Independent self-locking pneumatic needle valve perform mold: This means that the mold adopts advanced pneumatic needle valve technology, each cavity has independent self-locking function, which can ensure the stability and accuracy of the preform during the production process.

Concentricity within 0.05: this is one of the key indicators of the mold processing precision, which means that the preform produced by the mold needs to achieve a very high precision in terms of the concentricity, to ensure the quality and use effect of the preform.

Using stainless steel materials 2316, S136, 632: these stainless steel materials are high quality mold steel materials, with good corrosion resistance, wear resistance and high temperature resistance, can ensure the long-term stable operation of the mold and high quality production of preform.



| PET试管模具 PET test tube mold

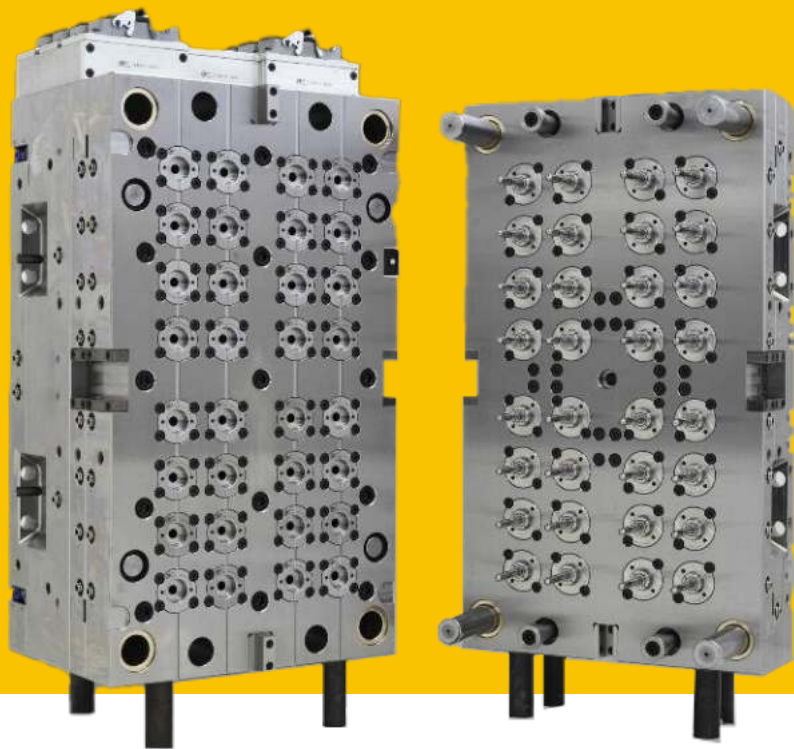

YONGSHENGMOULD

移液枪吸头模具 Liquid transfer gun suction head mould

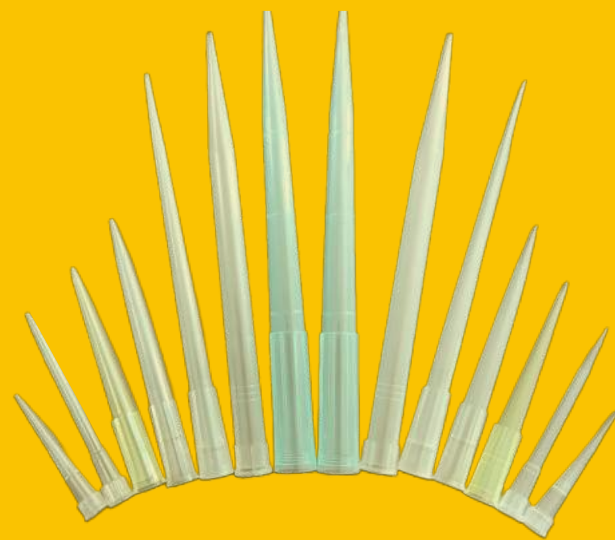
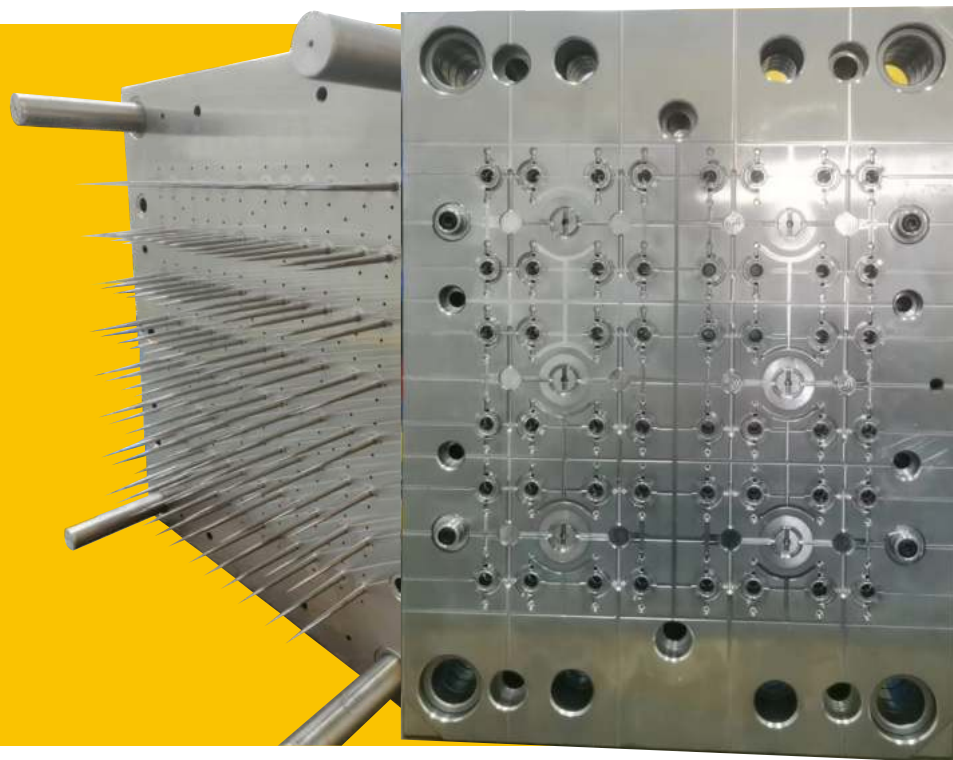

| 把手模具 Handle mold



YONGSHENGMOULD

医用注射器模具 Medical syringe mould



玻璃胶桶模具 Cartridge mould







YONGSHENGMOULD

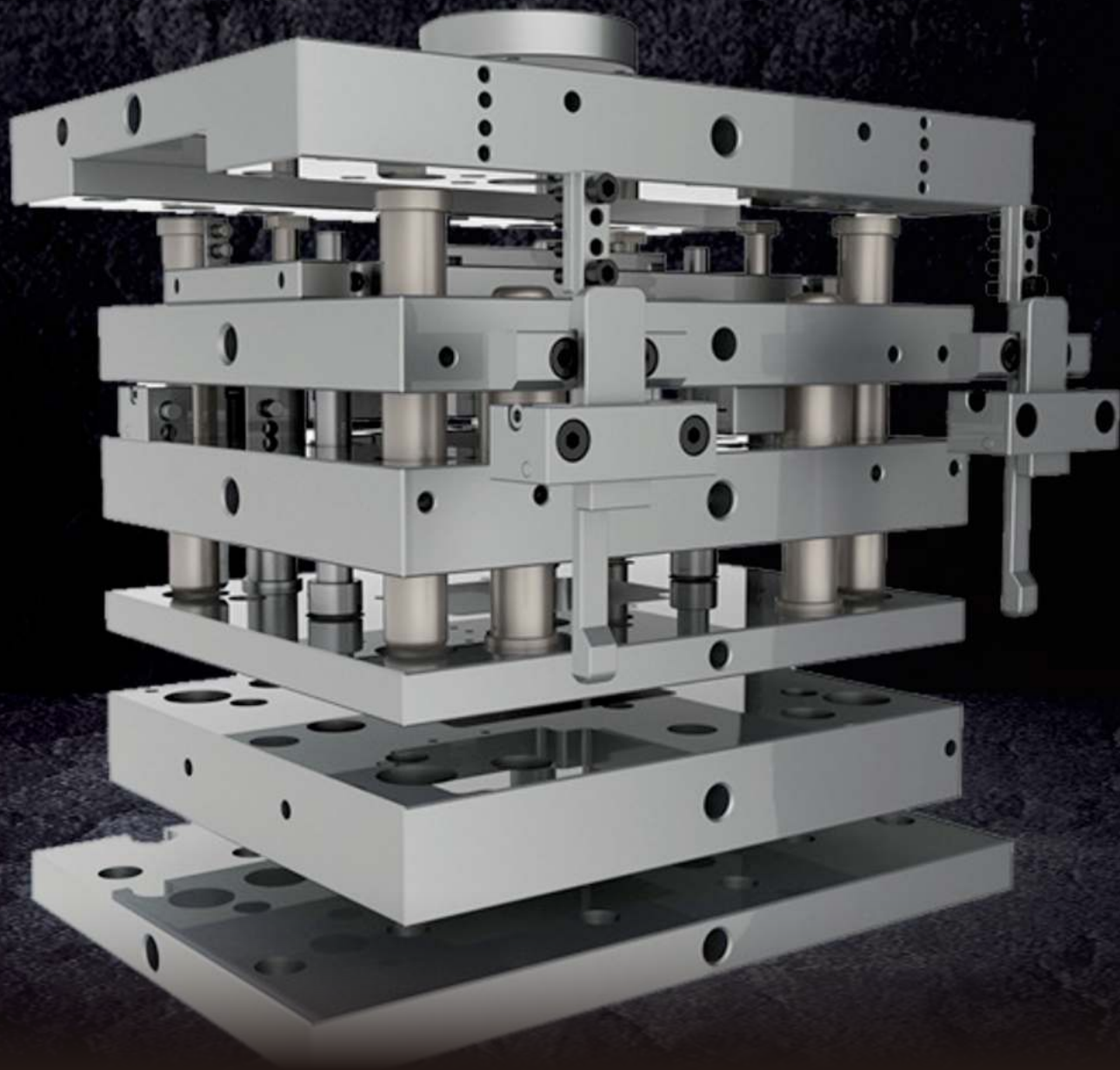

精于工

匠于心

品于行

台州市黄岩永生模业有限公司

地址:浙江省台州黄岩澄江石柜岙工业园区

电话(Tel):0576-84300930

传真(Fax):0576-84118949

微信号:ys382222360

Http://www.ysmou.com

E-mail:ys1@ysmou.com

Taizhou Huangyan Yongsheng Mold Co., Ltd.

 ShiGuiAo industry zoon, Chengjiang, HuangYan,TaiZhou,ZheJiang, China

 86-0576-84300930

 86-0576-84118949

 ys382222360

 Http://www.ysmou.com

 ys1@ysmou.com



YONGSHENGMOULD